

## Microstructure and Mechanical Properties of the Ultrafine-Grained Copper Tube Produced by Severe Plastic Deformation

H. Torabzadeh Kashi<sup>1</sup>, M. Bahrami<sup>1</sup>, J. Shahbazi Karami<sup>2</sup> and G. Faraji<sup>1\*</sup>

\* ghfaraji@ut.ac.ir

Received: December 2016

Accepted: April 2017

<sup>1</sup> Department of Mechanical Engineering, Faculty of Engineering, University of Tehran, Tehran, Iran.

<sup>2</sup> Faculty of Mechanical Engineering, Shahid Rajaei Teacher Training University, Tehran, Iran.

DOI: 10.22068/ijmse.14.2.32

**Abstract:** In this paper, cyclic flaring and sinking (CFS) as a new severe plastic deformation (SPD) method was employed to produce the ultrafine grain (UFG) copper tubes. The extra friction has eliminated in the CFS method that provided the possibility for production of longer UFG tubes compared to the other SPD methods. This process was done periodically to apply more strain and consequently finer grain size and better mechanical properties. The CFS was performed successfully on pure copper tubes up to eleven cycles. Mechanical properties of the initial and processed tubes were extracted from tensile tests in the different cycles. The remarkable increase in strength and decrease in ductility take place in the CFS-ed tubes. The material flow behavior during CFS processing was analyzed by optical microscopy (OM), and a model was presented for grain refinement mechanism of pure copper based on multiplication and migration of dislocations (MMD). This mechanism caused that the initial grains convert to elongated dislocation cells (subgrains) and then to equiaxed ultrafine grains in the higher cycles. The CFS method refined the microstructure to fine grains with the mean grain size of 1200nm from initial coarse grain size of 40 $\mu$ m.

**Keywords:** Severe plastic deformation, Copper tube, Grain refinement, Mechanical properties

### 1. INTRODUCTION

Ultrafine grained (UFG) materials have been introduced as a new generation of metal products with the superior and unique mechanical and physical properties [1, 2]. While strength in the ultrafine-grained metallic material is much higher than the coarse-grained material [3], their ductility is also good [4]. The ultrafine grained materials show excellent ductility properties even at lower temperatures and higher strain rates [5]. Many types of research were done to develop the ultra-fine metal production processes on a laboratory and industry scales. Ultrafine grained metals have a much higher strength-to-weight ratio. In UFG materials, there are other properties such as coaxial and homogeneous microstructure with high angle grain boundaries (HAGB) [6, 7]. The presence of plenty of high angle grain boundaries has a particular importance in achieving the desired properties. In this regard, studies had shown that one of the most effective ways of processing ultrafine grained metallic

material is the severe plastic deformation methods (SPD) [8]. In severe plastic deformation methods, high hydrostatic pressure with an intense shear strain cause to refine the microstructure and produce UFG materials [9]. On the other hand, hydrostatic pressure prevents cracks growth, therefore may severe deformations can be applied to the materials with low plasticity [10]. In the last decade, due to growing demand for tubular parts with high strength, some studies have been done to produce UFG tubes. Tooth et al. had Produced ultra-fine tubes using high-pressure tube twisting in 2009 [11]. Mohebi in 2010 had introduced a new method as accumulative spin-bonding (ASB) to produce this kind of tubes [12]. Zangiabadi et al. had masterminded producing high-strength tubes using tube channel pressing (TCP) [13]. Faraji et al. in 2011 had invented tube channel angular pressing (TCAP) process as the optimal way, inexpensively and with the industrial capability [14]. In 2012, parallel tubular channel angular pressing (PTCAP) was presented by Faraji [15].

Babaei et al. had taken an innovative step to produce UFG tubes with introducing of two new methods of tube cyclic expansion-extrusion (TCEE) and tube cyclic extrusion-compression (TCEC) [16, 17]. Jafarzadeh et al. had introduced a method under repetitive tube expansion and shrinking (RTES) and have reached success in the production of ultra-fine tubes [18]. More recently, Torabzadeh et al. have presented a method as cyclic flaring and sinking (CFS) by modifying the PTCAP [19]. In this method, with no extra friction, UFG tubes can be achieved with a longer length compared to other methods.

In the present study, The CFS was applied to manufacture the UFG pure copper tubular samples' up to eleven cycles. The CFS processed samples were perused regarding microstructural evolution and mechanical properties. The mechanism of grain refinement of pure copper was introduced during CFS process. Fracture surfaces after tensile tests were investigated by scanning electron microscopy (SEM).

## 2. PRINCIPLES OF CFS

Fig. 1 depicts schematic illustrations of CFS process. Cyclic flaring and sinking method consists two half-cycles. At first, the tube with the radius of  $R_1$  is pressed on the flaring punch, so that shear zones are made with tensile stress and the tube radius increases of up to  $R_2$  (Fig 1b). In the next half-cycle, the tube is forced into sinking die, and compressive stress is created at the same shear zones so that the initial radius is obtained (Fig 1c). By considering that the cross-section of the CFS-ed tube remains constant, this process can be repeated cyclic to impose the desired plastic strain on the material.

Fig. 1d depicts geometric parameters of deformation. Because the strain state of the CFS is similar to the PTCAP process [20], the strain calculation could be made similar to PTCAP process. So, the equivalent plastic strain at each half cycle is calculated using equation (1). ( $\psi_1 = \psi_2 = 0^\circ$ )

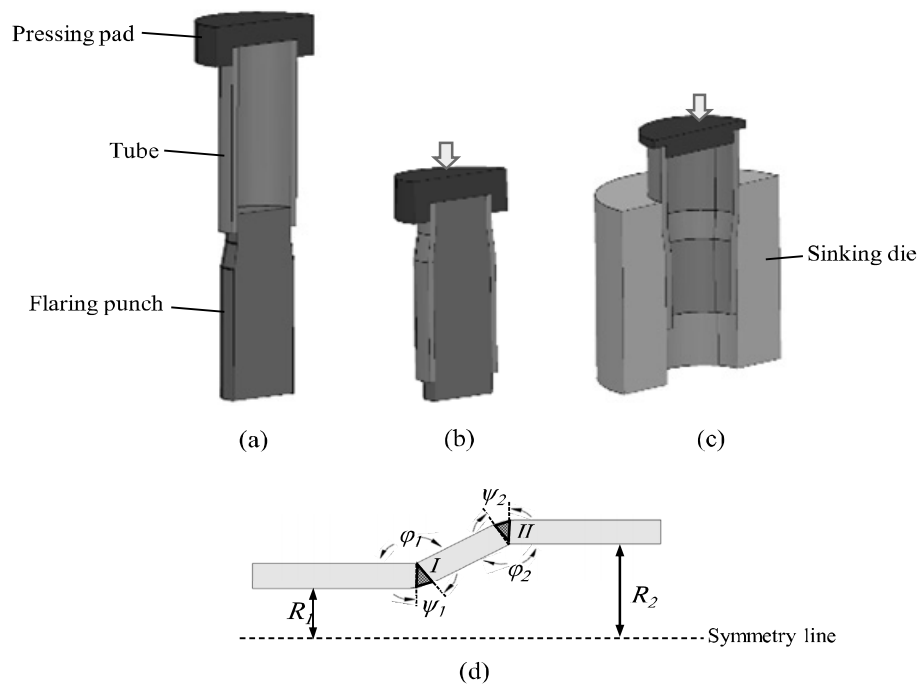

**Fig. 1.** The schematic illustration of the CFS method (a) initial state, (b) the flaring half-cycle, (c) the sinking half-cycles and (d) the geometric parameters.

$$\bar{\varepsilon}_T = \sum_{i=1}^2 \left[ \frac{2 \cot(\varphi_i / 2)}{\sqrt{3}} \right] + \frac{2}{\sqrt{3}} \ln \frac{R_2}{R_1} \quad (1)$$

Therefore total effective strain achieved after N cycles:

$$\bar{\varepsilon}_T = \sum_{i=1}^2 \left[ \frac{2 \cot(\varphi_i / 2)}{\sqrt{3}} \right] + \frac{2}{\sqrt{3}} \ln \frac{R_2}{R_1} \quad (2)$$

From Eq. (2), the equivalent plastic strain is about 0.45 after one cycle of CFS process with the parameters used in this work. The total equivalent plastic strain applied to the copper tubes after eleven CFS passes is about 5.

### 3. EXPERIMENT PROCEDURE

In this study, the CFS method was carried out on pure copper tubular samples. The outer diameter of tubes was chosen 22 mm, the thickness of 1.2 mm and a length of 70 mm. The flaring punch and sinking die were made of VCN 150 steel with a hardness of 25 HRC. Die parameters, and their values were: curvature angles  $\psi_1 = \psi_2 = 0^\circ$ , the channel angles  $\varphi_1 = \varphi_2 = 170^\circ$ ,  $R_2 = 11\text{mm}$  and  $R_1 = 9.8\text{mm}$ . The deformation ratio ( $K = R_2/R_1$ ) was considered the same as the tube thickness. The deformation ratio (K) is related to the die geometry and it represents the increase or decrease of tube

diameter in the flaring or sinking half-cycle. Therefore, the K value remains constant in all of the cycles. The CFS experiments were carried out by thread mechanism press with 150 mm/min speed at room temperature. As shown in Fig. 2, the tensile test sample was cut in the axial direction in order to explore the influences of the CFS process on mechanical properties. True stress- strain curves of tube obtained using a tensile test at room temperature and strain rate of  $5 \cdot 10^{-10} \text{ 1/s}$ .

## 4. RESULTS AND DISCUSSION

### 4. 1. Mechanical Properties

Fig. 3 shows the mechanical properties of the unprocessed and CFS processed tubes achieved from the tensile test through axial directions at room temperature. Fig. 3a shows the stress-strain curves of unprocessed and CFS processed tubes in the different cycles. Fig. 3b displays the extracted results from these diagrams for yield strength (YS), ultimate tensile strength (UTS) and the elongation (El). Yield strength (in 0.2% strain) in the initial state is 120 MPa, which increases to 165 MPa, 183 MPa and 185 MPa after three, five and eleven CFS cycles, respectively. Also, the ultimate tensile strength increases from  $\sim 180 \text{ MPa}$  to  $\sim 285 \text{ MPa}$  after eleven cycles. The tube strength increases due to reducing grain size and increasing the density of

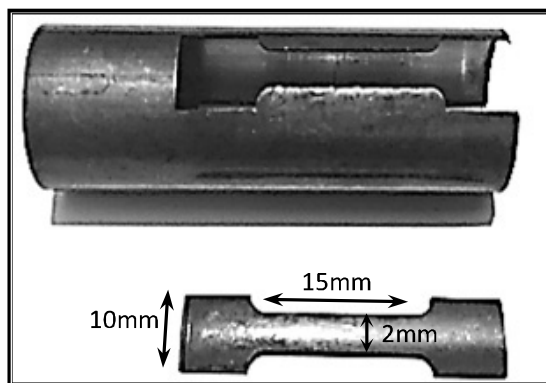
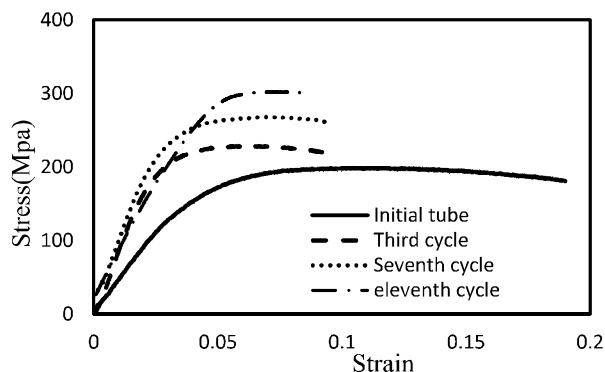
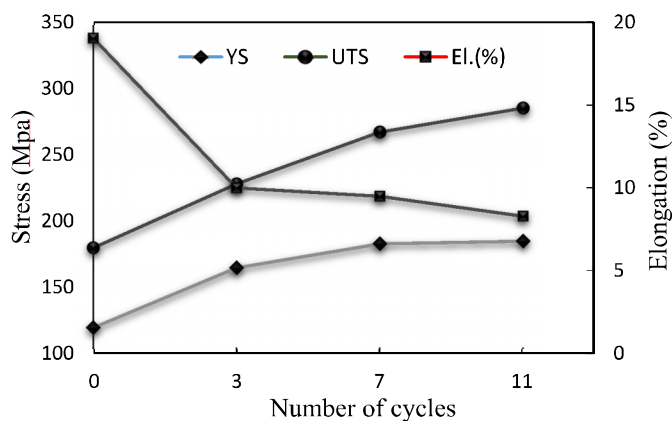

Fig. 2. Axial tensile test sample cut from unprocessed and CFS processed tube specimens.



(a)



(b)

Fig. 3. (a) Tensile true stress–true strain curves and (b) the variation of mechanical properties in the different cycles.

dislocations [21]. Also, the grain boundaries and twins operate as a barrier to the dislocation movement and increase the resistance to deformation of material which leads to amplification of strength [22]. So, after eleven cycles of CFS process, the yield strength of ~185 MPa and the ultimate tensile strength of ~285 MPa can be reached. In the other word, yield and tensile strengths increase about 230 % and 47 % occurs, respectively. As it is clear, elongations decreases after eleven cycles of CFS processing to 8% from the initial value of 14%. The increase in the strength by grain refinement can lead to a possible decrease in ductility as reported for other SPD methods such as ASB. With the increase in strength, instability or necking occurs earlier, and

the ductility of material reduces [12].

## 4. 2. Grain Refinement

Fig. 4 shows a cut section of the specimen parallel to the longitudinal axis during the process between the third and fourth cycle. As is evident, the tube is in the flaring step, and the material deforms in the shear zones (I) and (II). At first in Fig. 4a, the material microstructure consists of elongated grains in the longitudinal direction. Stretching of the grains has created as a result of applying severe plastic deformation in the previous three cycles [23]. When the material enters the shear zone (I), due to the normal and shear stress, the direction of material flow (MF)

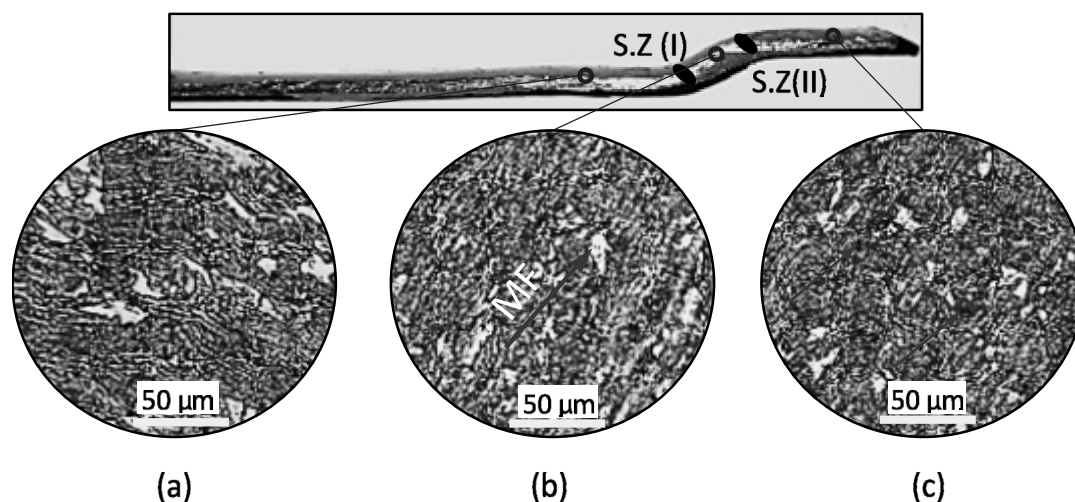

**Fig. 4.** The process of grain refinement between the third and fourth cycle, (a) before shear zone (I), (b) between shear zone (I) and shear zone (II) and (c) after shear zone (II).

changes. In the Fig. 4b, the orientation of grains has changed to the channel direction. Then the material approaches to the shear zone (II) and shear stress applies to the material once again. In Fig. 4c, the grains of the specimens after the shear zone (II) were significantly refined and, microstructure consists equiaxed grains compared to pre-shear zone (I). After the shear zone (II), the total accumulated equivalent plastic strain increases and the grain refinement occurs in the material [24]. The main factor is the shear strain that in addition to grain refinement, increases dislocations density in the microstructure [25, 26]. As shown by the red arrows in Fig. 4c, accumulation of dislocations was created by shear strains at different points of the material microstructure.

In order to study the microstructural evolutions after CFS processing, the OM images of unprocessed samples, after three and eleven cycles of CFS processed samples are shown in Fig. 5. As illustrated in Fig. 5a, there is the fully recrystallized heterogeneous microstructure of the unprocessed pure copper specimen with a mean grain size about 40  $\mu\text{m}$ . With applying plastic strain until three cycles, the original grains were elongated according to the shear direction, and the energy level of materials decreased.

These elongated grains were shown in Fig 5b that their thickness is very smaller than their length, with original grain boundaries still distinguishable. As seen in Fig. 5c, the microstructure of the specimen was significantly altered after eleven CFS cycles and is specifically different from the initial microstructure. After eleven cycles of CFS process, the structure was so much refined that the average grain size is about 1200 nm. Performing eleven cycles of CFS procedure on the material caused the microstructure uniformity increased, and equiaxed grains created in the material that corresponded to the previous studies [27, 28]. Fig. 5d shows the decline of average grain size versus the number of cycles. It is known that the reduction of grain size in the primary cycles was greater than the final cycles and the maximum reduction (30%) occurred after the second cycle. The decreasing in the grain sizes slowed down with increasing cycles, and the grain size stayed in nearly a constant value as a saturated grain size in the higher cycles. The microstructure evolution and grain refinement had occurred more on the primary cycles of SPD process [29].

In general, various mechanisms of refining pure copper in the SPD methods that have already introduced include shear deformation

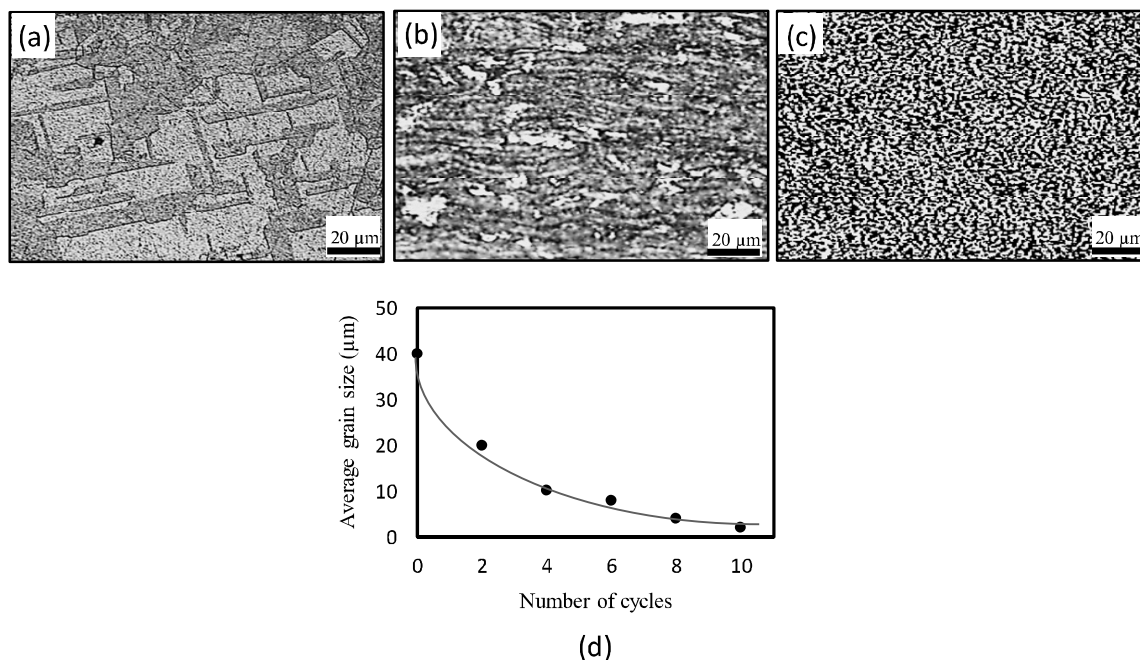

**Fig. 5.** (a) Microstructures of the unprocessed specimen, (b) after three cycles (c) after eleven cycles and (d) the average grain size in different cycles of CFS process.

[30], dislocation subdivision [31] and twin fragmentation [32]. According to the observed microstructural changes in Fig. 5, a model can be introduced for the dominant grain refinement mechanism in the UFG copper tubes. The model was shown in Fig. 6 which describes the procedure of the fragments original coarse grains and refines the microstructure to ultrafine grained in the severe plastic deformation methods. 1) At first, a random dislocation distribution is observed in Fig. 6a which is not a low-energy configuration. 2) As shown in Fig.6b, Due to applying strain, the dislocations density increases into an intra-granular that results in tangling of the dislocations with the regular arrangement and consequently formation of elongated dislocation cells ( $D_2 \gg D_1$ ). 3) As the deformation continues, the dislocations rearrange to form the boundaries of fine grains (Fig. 6c). 4) In higher cycles, accumulation of dislocations increases in the dislocation walls that causes to produce sub-grains with low angle boundaries. With increasing the deformation, the number of sub-grains increments until the material converts to

the UFG structure (Fig. 6d). 5) As is clear in the Fig 6e, in the higher cycles, the shear strain causes the sub-grains rotate relative to each other. Accordingly, the inter-granular sub-grains tends to disorient, and the high angle grain boundaries form in the material structure [33].

#### 4. 3. Fracture Surface

SEM was utilized to clarify the rupture mechanisms in the unprocessed, and the CFS processed pure copper samples. Fig. 7 depicts the images of a fractured surface of tensile samples in unprocessed and after seven cycles of CFS. The failure surface of samples consists a large number of dimples or microvoids that indicating ductile fracture mode [18]. The basic steps of ductile rupture are the formation of microvoids, coalescence of microvoids (also known as crack formation), propagation of crack and finally, the failure occurs [34]. As shown in Fig. 7(a), the initial specimen contained long and deep equiaxed dimples in the average size of  $\sim 20 \mu\text{m}$ . In ductile fracture, there is slow crack

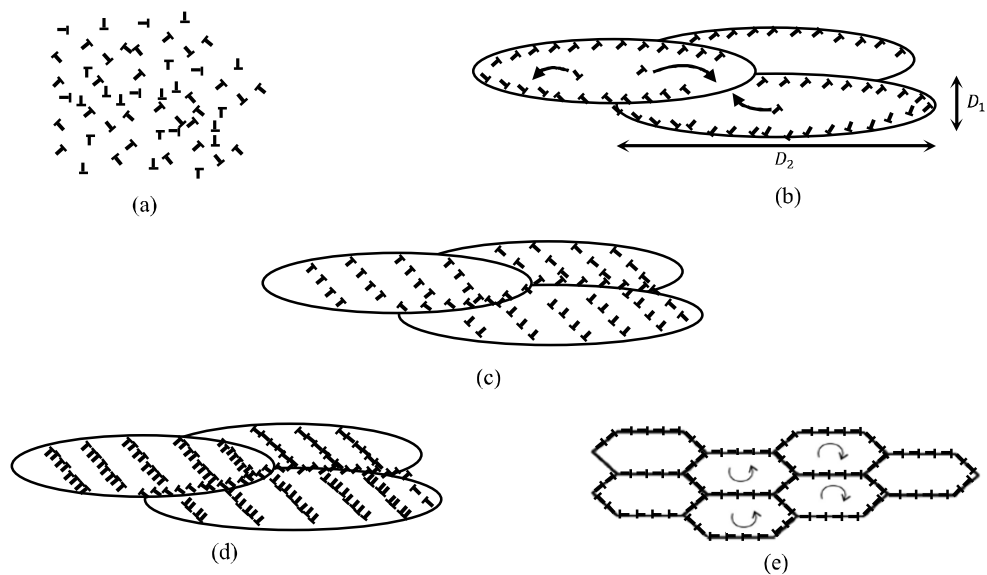

**Fig. 6.** Schematic of the grain refinement mechanism in the UFG copper tubes. (a) Random dislocation distribution, (b) Elongated grains, (c) the dislocations rearrange to form fine grain boundaries, (d) accumulation of dislocations in the wall and forming the subgrains and (e) Forming the high angle grain boundaries.

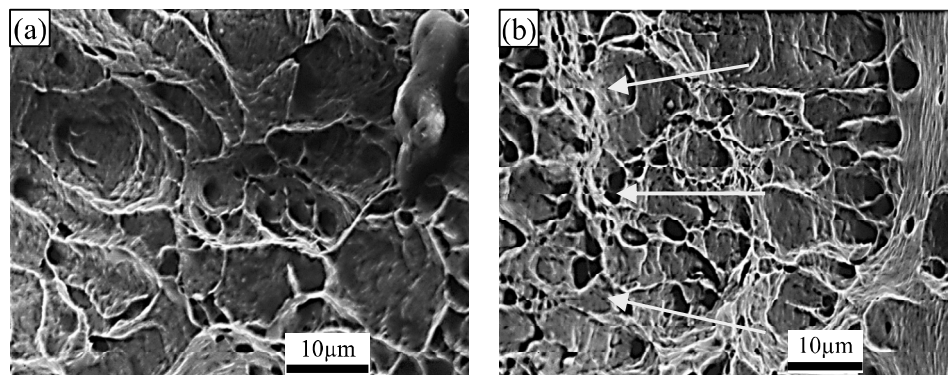

**Fig. 7.** SEM images of fractured surfaces after the tensile tests of a) unprocessed state, b) after seven cycles of CFS.

propagation and a large absorption of energy before fracture. So that, there is the required time for the formation of large and deep dimples during the tensile test [35]. Fig. 7(b) shows the samples after seven cycles of CFS process. In the CFS processed samples, the number of dimples has decreased, and the dimples distribution was changed on the fracture surface. In this mode, shallow and tiny dimples were observed that distributed more uniformly on fracture surface with the average size of  $\sim 1.5 \mu\text{m}$ . The decrease of

the dimple size is related to the grain refinement in the structure of the CFS processed tubes [36, 37]. With the decrease of ductility in the CFS processed samples, the dimples do not have enough time to grow and assemble with the other neighboring dimples. Therefore shallow dimples were observed in the samples after seven cycles of CFS [18]. Another issue is that the shallow dimples oriented toward the tension zone where the ultimate failure occurs (yellow arrows).

## 5. CONCLUSION

In this paper, a new method of severe plastic deformation as cyclic flaring and sinking (CFS) was used for the production of UFG copper tubes. This method was successfully applied to the pure copper tubes up to eleven cycles. The mechanical properties of the tubes significantly improved as a result of CFS method. The yield and tensile strength of pure copper increased up to 185 and 285 Mpa respectively after eleven cycles of CFS. The SEM images of the fracture surfaces depicted the fracture procedure which justified the decrease of ductility in the tubes after CFS process. The improvement of tube strength enhanced as a result of grain refinement in the processed samples. Optical observations documented remarkable grain refinement after CFS processing as the grain size the mean grain size reduced to 1200nm from the initial of 40 $\mu$ m. The presented grain refinement mechanism based on four stages with continuous applying plastic strain: a) the initial coarse grains converted to elongated grains through migration of dislocations. b) The dislocations rearranged on fine grain boundaries. c) The dislocation density increased on walls, and the subgrains were formed. d) The formed ultrafine grains rotated to one another, and the high grain boundaries (HAGBs) were produced. The presence of ultrafine grains with HAGBs was the main reason for the superior mechanical properties in the CFS-ed tubes.

## REFERENCE

1. Valiev, R. Z. and T. G. Langdon, "Principles of equal-channel angular pressing as a processing tool for grain refinement". *Progress in Materials Science*, 2006, 51, 881-981.
2. Beyerlein, I. J. and L. S. Tóth, "Texture evolution in equal-channel angular extrusion". *Progress in Materials Science*, 2009, 54, 427-510.
3. Kawasaki, M. and T. Langdon, "Principles of superplasticity in ultrafine-grained materials". *Journal of Materials Science*, 2007, 42, 1782-1796.
4. Máthis, K., J. Gubicza, and N. H. Nam, "Microstructure and mechanical behavior of AZ91 Mg alloy processed by equal channel angular pressing". *Journal of Alloys and Compounds*, 2005, 394, 194-199.
5. Matsunoshita, H., "Ultrafine-grained magnesium-lithium alloy processed by high-pressure torsion: Low-temperature superplasticity and potential for hydroforming". *Materials Science and Engineering: A*, 2015, 640, 443-448.
6. Valiev, R. Z., R. K. Islamgaliev, and I. V. Alexandrov, "Bulk nanostructured materials from severe plastic deformation". *Progress in Materials Science*, 2000, 45, 103-189.
7. Zhilyaev, A. P. and T. G. Langdon, "Using high-pressure torsion for metal processing: Fundamentals and applications". *Progress in Materials Science*, 2008, 53, 893-979.
8. Sabirov, I., M. Y. Murashkin, and R. Z. Valiev, "Nanostructured aluminium alloys produced by severe plastic deformation: New horizons in development". *Materials Science and Engineering: A*, 2013, 560, 1-24.
9. Valiev, R., "Producing bulk ultrafine-grained materials by severe plastic deformation". *JOM*, 2006, 58, 33-39.
10. Zhilyaev, A. P., "The microstructural characteristics of ultrafine-grained nickel". *Materials Science and Engineering: A*, 2005, 391, 377-389.
11. Tóth, L. S., "Severe plastic deformation of metals by high-pressure tube twisting". *Scripta Materialia*, 2009, 60, 175-177.
12. Mohebbi, M. S. and A. Akbarzadeh, "Accumulative spin-bonding (ASB) as a novel SPD process for fabrication of nanostructured tubes". *Materials Science and Engineering: A*, 2010, 528, 180-188.
13. Zangiabadi, A. and M. Kazeminezhad, "Development of a novel severe plastic deformation method for tubular materials," *Tube Channel Pressing (TCP)*. *Materials Science and Engineering: A*, 2011, 528, 5066-5072.
14. Faraji, G., M. M. Mashhadi, and H. S. Kim, "Tubular channel angular pressing (TCAP) as a novel severe plastic deformation method for cylindrical tubes". *Materials Letters*, 2011, 65, 3009-3012.
15. Faraji, G., et al., *Parallel tubular channel*



- angular pressing (PTCAP) as a new severe plastic deformation method for cylindrical tubes. *Materials Letters*, 2012, 77, 82-85.
16. Babaei, A., M. M. Mashhadi, and H. Jafarzadeh, "Tube Cyclic Extrusion-Compression (TCEC) as a novel severe plastic deformation method for cylindrical tubes". *Materials Science and Engineering: A*, 2014, 598, 1-6.
  17. Babaei, A., M. M. Mashhadi, and H. Jafarzadeh, "Tube cyclic expansion-extrusion (TCEE) as a novel severe plastic deformation method for cylindrical tubes". *Journal of Materials Science*, 2014, 49, 3158-3165.
  18. Jafarzadeh, H. and K. Abrinia, "Fabrication of ultra-fine grained aluminium tubes by RTES technique". *Materials Characterization*, 2015, 102, 1-8.
  19. Torabzadeh, H., G. Faraji, and E. Zalnezhad, "Cyclic Flaring and Sinking (CFS) as a New Severe Plastic Deformation Method for Thin-walled Cylindrical Tubes". *Transactions of the Indian Institute of Metals*, 2015, 1-6.
  20. Faraji, G., "Parallel tubular channel angular pressing (PTCAP) as a new severe plastic deformation method for cylindrical tubes". *Materials Letters*, 2012, 77, 82-85.
  21. Afrasiab, M., "Excellent energy absorption capacity of nanostructured Cu-Zn thin-walled tube". *Materials Science and Engineering: A*, 2014, 141-144.
  22. Tavakkoli, V., "Severe mechanical anisotropy of high-strength ultrafine grained Cu-Zn tubes processed by parallel tubular channel angular pressing (PTCAP)". *Materials Science and Engineering: A*, 2015, 625, 50-55.
  23. Arzaghi, M., "Microstructure, texture and mechanical properties of aluminum processed by high-pressure tube twisting". *Acta Materialia*, 2012, 60, 4393-4408.
  24. Jamali, S. S., G. Faraji, and K. Abrinia, "Hydrostatic radial forward tube extrusion as a new plastic deformation method for producing seamless tubes". *The International Journal of Advanced Manufacturing Technology*, 2016, 1-11.
  25. Mesbah, M., G. Faraji, and A. R. Bushroa, "Characterization of nanostructured pure aluminum tubes produced by tubular channel angular pressing (TCAP)". *Materials Science and Engineering: A*, 2014, 590, 289-294.
  26. Haghdad, N., et al., "An investigation into the homogeneity of microstructure, strain pattern and hardness of pure aluminum processed by accumulative back extrusion". *Materials Science and Engineering: A*, 2014, 595, 179-187.
  27. Zhu, C. F., "Microstructure and strength of pure Cu with large grains processed by equal channel angular pressing". *Materials & Design*, 2013, 52, 23-29.
  28. Mishra, A., et al., "Microstructural evolution in copper processed by severe plastic deformation". *Materials Science and Engineering: A*, 2005, 410-411, 290-298.
  29. Nemati, J., "Improvements in the microstructure and fatigue behavior of pure copper using equal channel angular extrusion". *International Journal of Minerals, Metallurgy, and Materials*, 2014, 21, 569-576.
  30. Segal, V. M., "Severe plastic deformation: simple shear versus pure shear". *Materials Science and Engineering: A*, 2002, 338, 331-344.
  31. Zhang, Z. J., "Microstructure and mechanical properties of Cu and Cu-Zn alloys produced by equal channel angular pressing". *Materials Science and Engineering: A*, 2011, 528, 4259-4267.
  32. Qu, S., "Microstructural evolution and mechanical properties of Cu-Al alloys subjected to equal channel angular pressing". *Acta Materialia*, 2009, 57, 1586-1601.
  33. Wang, K., "Plastic strain-induced grain refinement at the nanometer scale in copper." *Acta Materialia*, 2006, 54, 5281-5291.
  34. Courtney, T. H., "Mechanical Behavior of Materials," Second Edition. 2005: Waveland Press.
  35. Davis, J. R., *Tensile Testing*, 2nd Edition. 2004: A S M International.
  36. Pippin, R., "The Limits of Refinement by Severe Plastic Deformation". *Advanced Engineering Materials*, 2006, 8, 1046-1056.
  37. Babaei, A. and M. M. Mashhadi, "Tubular pure copper grain refining by tube cyclic extrusion-compression (TCEC) as a severe plastic deformation technique". *Progress in Natural Science: Materials International*, 2014, 24, 623-630.