

The Effects of Plasma Spray Parameters on the Microstructure and Phase Composition of Thermal Barrier Coatings Made by SPPS Process

Z. Valefi* and M. Saremi

* ziavalefi@ut.ac.ir

Received: April 2016

Accepted: April 2017

¹ Maleke Ashtar University of Technology, Tehran, Iran.

² Department of Metallurgy and Materials, Faculty of Engineering, University of Tehran, Tehran, Iran.

DOI: 10.22068/ijmse.14.2.11

Abstract: In this paper the effect of plasma spray parameters, atomizing gas and substrate preheat temperature on microstructure and phase composition of YSZ coatings produced by SPPS process have been investigated. The experimental results showed that increasing the power of plasma, using hydrogen as the precursor atomizing gas and increasing substrate preheat temperature decrease the amount of non-pyrolyzed precursor in the coatings. At low plasma power most of the deposited precursor is in non-pyrolyzed state, and consequently the applied coatings are defective. The increase in substrate temperature beyond 800 °C either by preheating or heat transfer from plasma torch to the substrate, prevent the coating formation. In SPPS coating formation, up to a special spray distance the optical microscopy image of the coatings showed a snowy like appearance. XRD analysis showed that in this situation the amount of un-pyrolyzed precursor is low. Beyond this spray distance spherical particles are obtained and XRD analysis showed that most of the precursor is in un-pyrolyzed state.

Keywords: Thermal Barrier Coatings, Solution Precursor plasma Spray, Precursor Atomizing, Ytria Stabilized Zirconia

1. INTRODUCTION

Thermal barrier coatings (TBCs) have been widely used in various gas turbines for aircraft propulsion, power generation, and marine propulsion [1–4]. Current TBCs are made by air plasma spray (APS) or electron beam physical vapor deposition (EB-PVD) processes. More recently, a solution precursor plasma spray (SPPS) process has been developed to deposit various ceramic coatings [5–10]. TBCs made by this process have demonstrated improved durability over a range of TBC thicknesses [11], due to their unique microstructure.

It is widely recognized that deposition of small, melted particles achieves a fine microstructure, which in turn leads to improvements in certain desirable mechanical properties such as strength and hardness of the coatings. Unfortunately, it is generally not possible to feed powders finer than 5-10 μm to plasma torch due to the effects of surface forces on powder flow. Recently, the suspension plasma spray process (SPS) was developed to overcome

this limitation [12-14]. In this process, nano-sized particles are suspended in a liquid before injection into the plasma plume, circumventing normal feeding problems.

In SPPS process an atomizer nozzle injects the solution of final material precursor into the plasma flame. The precursor usually used for YSZ TBCs, is an aqueous solution containing zirconium and yttrium salts. As with suspension, the liquid undergoes rapid fragmentation and evaporation once injected in the plasma jet. This is followed by precipitation or gelation, pyrolysis and melting to result droplets with average diameters ranging from 0.1 to a few micrometers [15–17].

Three major zones can be identified within the plasma flow:

- The plasma jet core ($T > 8000$ K) where the liquid can encounter the highest heat and momentum transfers,
- The plasma plume ($3000 < T < 6000$ K) where the heat and momentum capabilities from the plasma are drastically reduced

- compared to the ones in the plasma core, The plasma fringe (around the plasma core) where the momentum might be high enough to fragment the liquid

The droplet momentum and injection location determine which area of the plasma plume a droplet will entrain and this in turn determines the thermal, or time-temperature, history of that droplet. Also spray parameters determine heat transfer to the atomized droplet. Substrate temperature affects pyrolysis reactions on the surface of coatings. Since the chemical and physical processes that a droplet undergoes are dependent on the heating that it experiences, the deposition state of the coating is a direct function of this thermal history. Once entrained, a droplet undergoes some or all of the following processes depending on the amount of heat transferred to it from the plasma: precursor solvent evaporation, droplet breakup, precursor solute precipitation, pyrolysis, sintering, melting, and crystallization [18].

In this paper the effect of plasma spray parameters, atomizing gas and substrate preheat temperature on microstructure and phase composition of TBCs applied by SPPS process have been studied.

2. EXPERIMENTAL PROCEDURE

2. 1. Materials Used

An aqueous saturated solution containing zirconium oxy-nitrate and yttrium nitrate salts was used as precursor. The amounts of these salts in the solution were considered to result 93 wt% ZrO_2 and 7 wt% Y_2O_3 in the coating. To make saturated solution, the calculated amounts of $ZrO(NO_3)_2$ and $Y(NO_3)_3 \cdot 6H_2O$ were added to 500 cm^3 distilled water at 50 °C while mixing with a magnet. At first the salts dissolve in water and a colorless solution results. Then the salts

start to deposit that show a super saturated solution has been made which was used as solution precursor.

The substrates were stainless steel type AISI 420 disks of 25 mm diameter and 10 mm thickness. The specimens after roughening by grit blasting with alumina grits mesh 36 were coated with MCrAlY alloy (Amdry 962) as bond coat by atmospheric plasma spray method (Sulzer-Metco F4 gun) to reach the thickness of 80-100 μm . Spray parameters are shown in table 1. These specimens then were coated to a thickness of 200 μm by SPPS method.

2. 2. Processing

The coatings were applied using F4 plasma spray torch (Sulzer-Metco). To inject solution precursor into the plasma jet, an atomizer suitable to be mounted on this torch was made. The nozzle diameter of the atomizer was 0.3 mm. Two kinds of atomizing gas were used; O_2 with flow rate of 6 slpm and H_2 with flow rates of 6 and 8 slpm. To reduce the danger of using H_2 as atomizing gas, two flash back arrestors after the regulator and before the atomizer have been used. The pressure of atomizing gas (H_2 or O_2) was 3.5 bar adjusted on the exit of the gas regulator. The flow rate of the atomizing gas was adjusted by a ball flowmeter. Solution precursor flow rate of 30 cm^3/min at spray distances of 4 to 20 cm were used.

Two plasma powers of 18.5 and 34.5 KW and three substrate preheating temperatures of 200, 500 and 800°C were studied. The spray parameters are summarized in table 2. To study the effect of spray distance on coatings morphology, a specimen holder schematically shown in Fig. 1 was used. Ten specimens with 2 cm distances related to each other can be mounted on this holder. The vertical traverse speed for plasma gun was 5 cm/s and after each

Table1. Spray parameters of depositing bond coat by APS

Ar (slpm)	H ₂ (slpm)	Current (A)	Voltage	Injector diameter (mm)	Injector angle (degree)	Injector distance (mm)	Powder gas Ar (slpm)	Powder feed rate (g/min)	Spray distance (mm)
65	14	600	75	1.5	90	6	2.3	40	140

Table 2. Spray parameters used in this study

Experiment number	Current (A)	Plasma gas Ar (slpm)	Plasma gas H ₂ (slpm)	Power (KW)	Atomizing gas	Atomizing gas flow rate at pressure 3.5 bar (slpm)	Substrate preheat Tcmp. (°C)
1	300	35	8	18.5	O ₂	6	200
2	600	35	12	34.5	O ₂	6	200
3	600	35	12	34.5	H ₂	6	200
4	600	35	12	34.5	H ₂	8	200
5	600	35	12	34.5	O ₂	6	500
6	600	35	12 </td <td>34.5</td> <td>H₂</td> <td>6</td> <td>500</td>	34.5	H ₂	6	500
7	600	35	12	34.5	O ₂	6	800
8	600	35	12	34.5	H ₂	6	800

pass of plasma gun, a horizontal displacement of 5 mm of specimen holder caused all surfaces of the specimens to be coated. The coating process proceeded till the thickness of $250 \pm 50 \mu\text{m}$ was attained. The specimens with lower spray distances because of higher spray efficiency gain the mentioned thickness earlier than specimens with higher spray distance so they discharged from the fixture earlier than the specimens with higher spray distance.

2. 3. Characterization

The surface morphology of deposits were characterized by light and Scanning Electron Microscope (SEM). To determine the phase composition of coatings XRD test (Cu K-radiation; D5005, Bruker AXS, Karlsruhe, Germany) was used. The temperatures of specimens were measured by an optical pyrometer.

To study the thermal shock resistance of coatings, the coated specimens were held in a box furnace at 900 °C for 10 min and then quenched to room temperature water. After 500 thermal cycles the surface of coatings were studied by optical microscope.

3. RESULTS

3. 1. Characterization of Solution Precursor

To determine the phases resulted from pyrolysis reactions by XRD analysis, some of the solution precursor was heated at 550 °C for 5 hours and the resulted material was grinded to result a powder in the range of 20–45 μm . Fig. 2

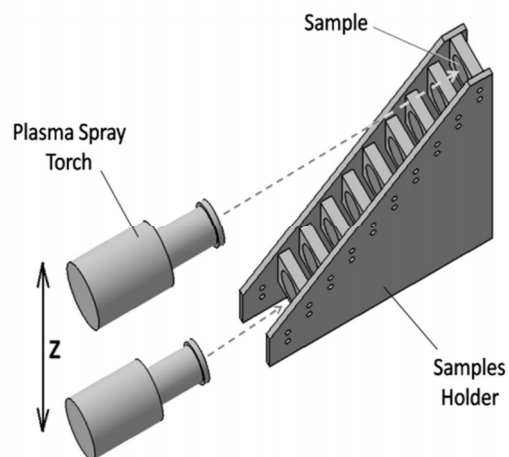

Fig. 1. Specimens mounted on fixture at distances of 2 cm related to each other.

shows the result of XRD analysis. According to the work of Chen [19] it can be seen that the powder is mainly composed of stabilized Zirconia. This also can be recognized from the XRD PDF file number 81-1544 [20]. The background of XRD peaks shows that some precursor still is in un-pyrolyzed state. Recognition of Y_2O_3 peaks was not possible because Y_2O_3 is expected to be doped inside ZrO_2 crystal structure.

3. 2. Optical Microscope Images of the Coatings Surface

Fig. 3 shows the optical microscope images from the surface of coatings deposited by the parameters of test 1 in Table 1 at spray distances 4 to 20 cm. It can be seen that coating deposited at spray distance 4 cm contains cracks and is

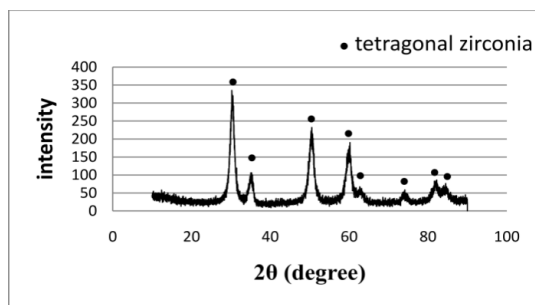

Fig. 2. XRD analysis of solution precursor pyrolyzed at 600 °C.

defective. At spray distance of 6 cm these cracks are not observed and again at spray distances 8 to 18 cm these cracks appear. The amount of cracking is low at spray distances up to 10 cm and is increased at higher spray distances up to 16

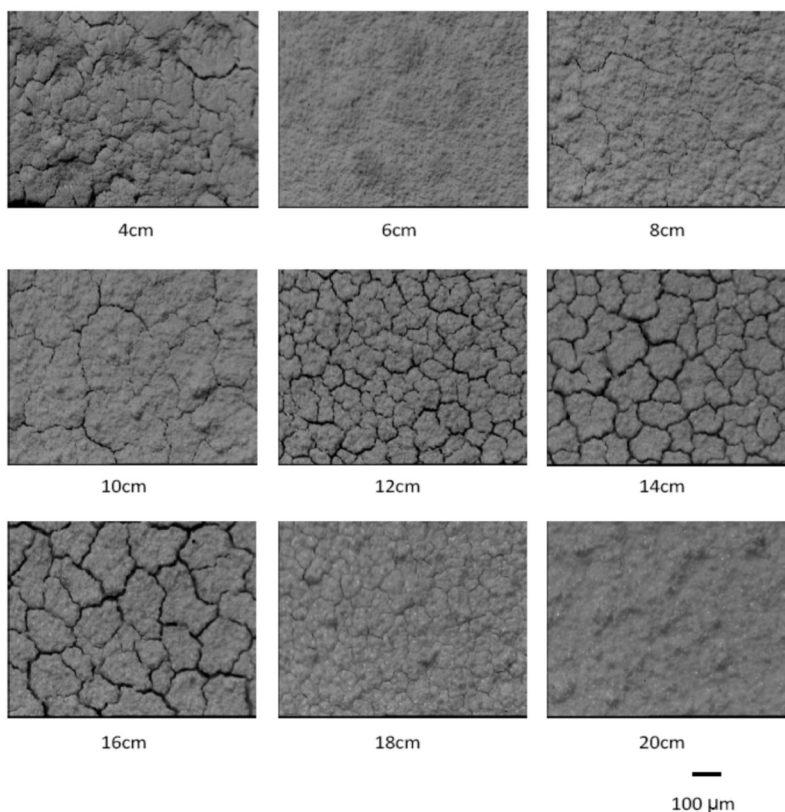

Fig. 3. Optical microscopy images from the surface of coatings produced under condition of test 1 at spray distances of 4 to 20cm ($\times 100$).

cm while decreased again at spray distance of 18 cm. No crack was observed at spray distances more than 18 cm.

To explain this observation it should be considered that evaporation of solute and pyrolysis of precursor can be done in two steps; the first step occurs when the atomized precursor is injected into the plasma jet. At this step depending on injection and atomizing conditions, some of the solution enters the hot zone of the plasma jet in which it will breakup to fine particles and then the pyrolysis, crystallization and melting can occur [21]. The remaining part enters the lower temperature zone of plasma in which the evaporation of precursor solute or pyrolysis reactions may not be done completely. At the second step depending on preheating temperature of substrate and the heat transferred from plasma torch to substrate solute evaporation

or pyrolysis reactions can be occurred on the substrate. Obviously by decreasing the spray distance more heat transfers to the substrate and these reactions will be done severely.

In the condition of test 1, in which the power of plasma is low, complete evaporation and pyrolyzation of the solution precursor would not occur.

It seems that at spray distance of 4 cm there is not enough time for complete evaporation of precursor solute while reaching the surface of substrate. So the mud-flat cracks observed in coatings are due to rapid evaporation of precursor solute by high heat transfer from the plasma to the layers formed on the substrate.

Lack of cracks at spray distance of 6 cm proposes that the cracking seen at more spray distances should have another reason. Xie [22] showed that unpyrolyzed precursor starts to

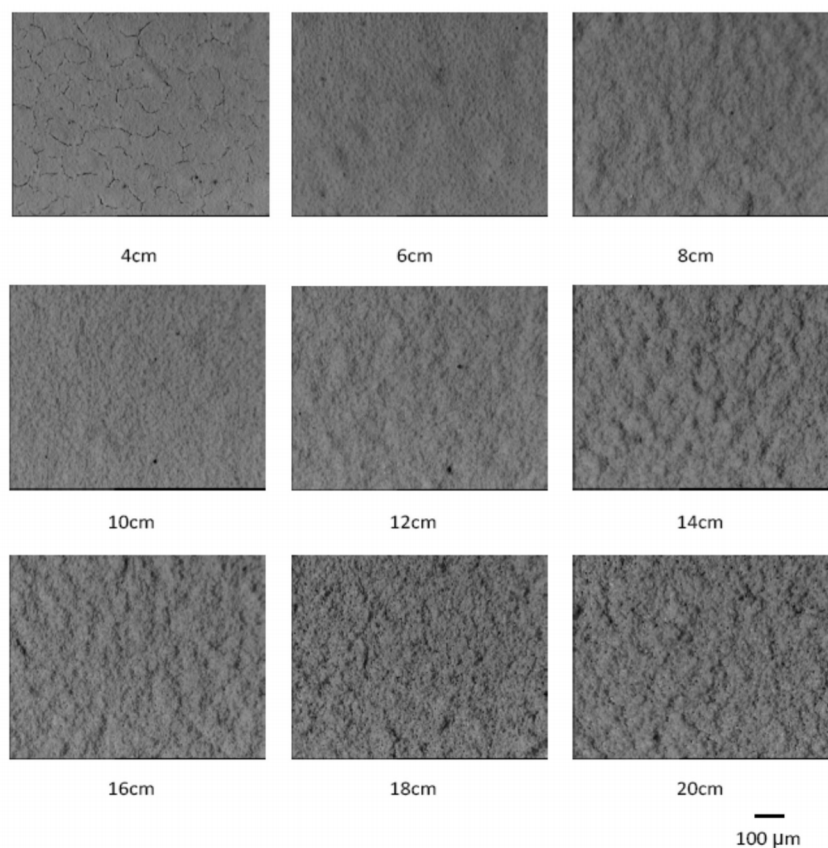

Fig. 4. Optical microscopy images from the surface of coatings produced under condition of test 2 at spray distances of 4 to 20cm ($\times 100$).

decompose at temperatures above 350°C. The decomposition of precursor causes contraction and tensile stresses which can cause cracking in the coating structure. Because of low plasma power used in test 1, much of the precursor remains unpyrolyzed and heat transferred from plasma torch to the layers already formed on substrate causes pyrolyzation to occur and the resulted stresses cause cracking. Lack of cracking in coatings produced at spray distances of 20 cm and more shows that at these distances the heat transferred from plasma torch to substrate was not enough to cause pyrolyzation.

As mentioned earlier when the droplets enter the hot zone of the plasma core, they breakup to finer particles. Because of lower volume of these particles, the pyrolysis and crystallization reactions can occur to a large extent. By increasing the spray distance the percent of fine particles which reach the substrate and contribute to the coating structure decreases and the result will be increase in un-pyrolyzed precursor in the deposited coatings. Therefore more volume of the precursor undergoes pyrolyze reaction and the cracking will be more severe. This is the trend observed at spray distances up to 16 cm. At spray

distance of 18 cm because heat transfer from plasma to substrate is low the pyrolyzation could not occur to a large extent and cracking is low. At higher spray distances no cracks are seen.

Another result from Fig. 3 is that up to spray distance of 10 cm the coatings have a snowy like structure but at spray distances above 10 cm the coatings are composed of sphere particles.

In Fig. 4 optical microscope images from the surface of coatings formed under the condition of test 2 are shown. In this case also the coating formed at spray distance of 4 cm is defective while at other spray distances no cracks are observed. The reason may be the more heat transferred to both atomized precursor and layers formed on substrate because of higher plasma power used in this test which reduces the amount of un-pyrolyzed precursor. Consequently the tensile stress resulted from pyrolyzation of precursor will be lower. Another observation from Fig. 4 is that up to spray distances 14 cm the coatings has a snowy like appearance and at higher spray distances coatings are composed of spherical particles.

Fig. 5 shows the optical microscope images from the surface of coatings formed under the

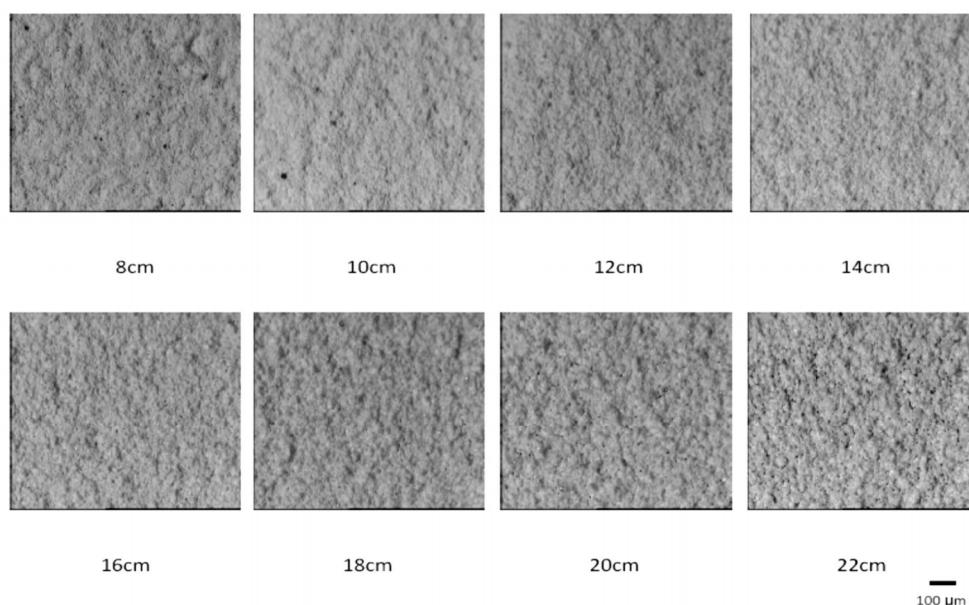

Fig. 5. Optical microscopy images from the surface of coatings produced under condition of test 3 at spray distances of 8 to 22cm ($\times 100$).

condition of test 3. It can be seen that at all spray distances the coatings are crack free. This demonstrates the presence of low amount of unpyrolyzed precursor in coating structure because of using H_2 as the atomizing gas which increases the enthalpy of plasma and transfers more heat to atomized precursor and layers formed on substrate. Also up to spray distance 16 cm coatings have a snowy like appearance.

The coatings formed under the condition of test 4, similar to coatings of test 3, show no cracking but the snowy like appearance is observed at spray distances lower than 18 cm.

In Fig. 6 the optical microscope images from the surface of coatings formed under the condition of test 5 are shown. By preheating the substrate up to $500^\circ C$ no cracks were observed in the structure at all spray distances. It seems that some of the unpyrolyzed precursors reaching the high temperature substrate surface, pyrolyze immediately and the amount of unpyrolyzed precursor in the coating structure, which during

the subsequent passes of plasma torch undergoes pyrolyzation, is not enough to cause cracking in the coatings. Also up to spray distance of 18 cm coatings have a snowy like appearance. At spray distances lower than 12 cm deposit formation was not possible. Measuring the substrate temperature at this condition showed that the substrate temperature have been raised up to $800^\circ C$ and it seems that the resulted radiation prevents coating formation. This situation also encountered in conditions of tests 6-8 in which coatings formation were not possible.

3. 3. XRD Results

To determine the crystal structure of the coatings, XRD tests were done on the coatings produced under the conditions of test 2 at spray distances 6 and 16 cm and on coating produced under the condition of test 3 at spray distance of 6 cm. The results are shown in Fig. 7. The coatings are mainly composed of stabilized

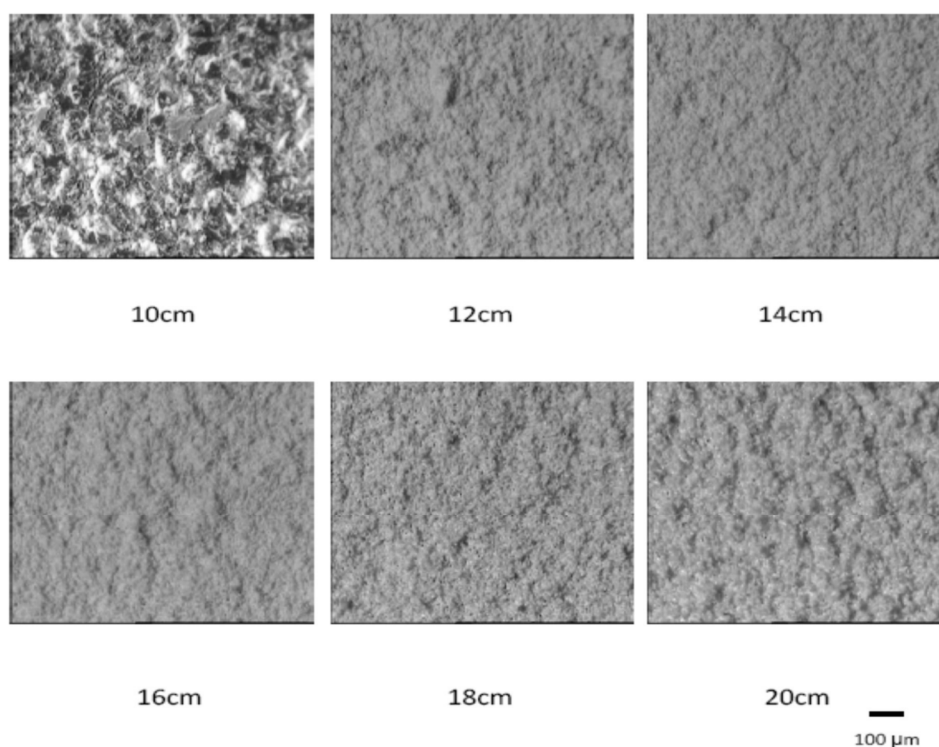

Fig. 6. Optical microscopy images from the surface of coatings produced under condition of test 5 at spray distances of 10 to 20cm ($\times 100$).

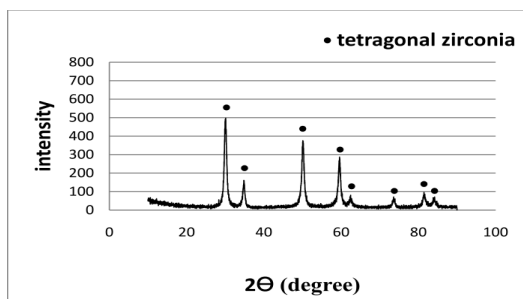

Fig. 7 a

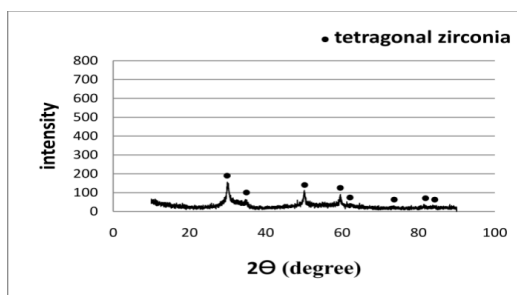

Fig. 7 b

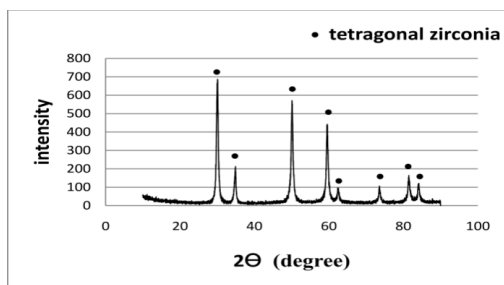

Fig. 7 c

Fig. 7. Results of XRD test for coatings produced under the condition of test 2 at spray distances of 6cm (a) and 16cm (b) and coating produced under the condition of test 3 at spray distance of 6cm (c).

tetragonal Zirconia. Comparing Fig. 7(a) and Fig. 7(b) shows that the amount of tetragonal phase in coatings formed at spray distance of 6 cm is more than spray distance of 16 cm in which the background peak shows the presence of a lot of

amorphous phase due to unpyrolyzed precursor. It seems that at spray distance of 6 cm the heat transferred from the plasma to the coatings already formed, is more than spray distance of 16cm and this can increase the pyrolysis reactions and crystallization on the substrate. Also from Fig. 7(c) it can be observed that the amount of crystallization when H_2 is used as the atomizing gas is higher than similar conditions but using O_2 as the atomizing gas. The reason can be higher enthalpy because of using H_2 atomizing gas which increases the pyrolyzation reactions and crystallization both in plasma and on the layers already deposited on substrate. By considering the results of XRD tests and optical microscope images, it can be concluded that the snowy like appearance of the coatings resembles atomized particles that undergo the pyrolysis and crystallization reactions to a large extent and spherical particles resemble atomized particles that do not get enough heat for pyrolyzation and crystallization. When the droplets enter the plasma jet, they undergo post injection breakup. Thus we can expect a combination of particles which reach the substrate surface in different conditions. By considering spherical particles with the size in the range of the atomized particles in the structure of coatings at high spray distances, it can be concluded that the part of the atomized particles that undergo the breakup process, do not reach the substrate at high spray distances.

By comparison of spray distances which form snowy like coatings, it can be concluded that by increasing the enthalpy of plasma, these distances shift to higher amounts. The results are shown in Table 3.

The results of XRD studies show that the final coatings contain large amounts of unpyrolyzed material, although the amount of it is lower for coatings produced by using H_2 atomizing gas. And this shows the merit of using H_2 atomizing gas. The completion of pyrolyzation can be done by a post heat treatment or during service at high temperature.

3. 4. SEM Results

Fig. 8 shows the SEM images from the section

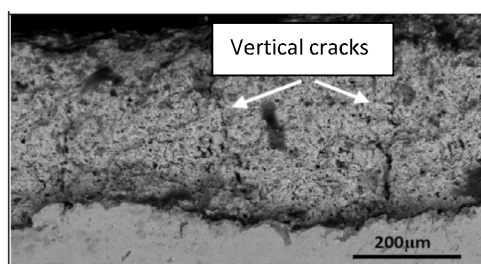

(a)

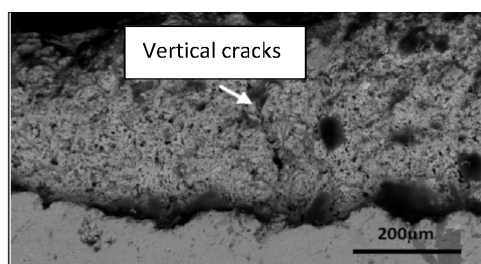

(b)

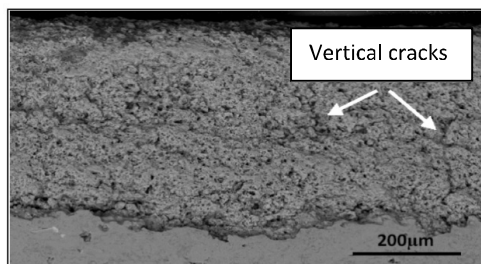

(c)

Fig. 8. SEM images from the section of coatings produced under the condition of test 2 at spray distances of 6 cm (a) and 16 cm (b) and test 3 at spray distance of 6 cm.

of coatings produced under the condition of test 2 at spray distances of 6 and 16 cm and test 3 at spray distance of 6 cm. In Fig.8 (a) vertical cracks, which are the characteristic of SPPS coatings, can be observed. Formation of these cracks has been studied by Xie [22]. He showed that the origin of cracks is pyrolyzation of the remained precursor in coatings as the result of heat transferred to the coating during coating build up from the plasma torch or subsequent exposure at high temperature service. These cracks are a positive characteristic of SPPS coatings because improve the thermal shock resistance of them.

In Fig. 8(b) it can be observed that coating formed at spray distance of 16 cm is less compact than spray distance of 6 cm. From table 3 it can be concluded that pyrolyzation hasn't been done to a large extent.

In Fig. 8(c) it can be seen that using H₂ atomizing gas resulted a more compact microstructure. Presence of vertical cracks in this case shows that in spite of higher enthalpy of plasma and heat transferred to the substrate, there is still unpyrolysed precursor in the coating.

Fig. 9 shows the SEM images from the surface of coating produced under the condition of test 2 at spray distance of 6 cm. The structure of coating mainly composes of splats, spherical particles with diameters in the range of less than 50 nm to more than 1000 nm and unpyrolyzed precursor. These particles are fractured atomized droplets

Table 3. Effect of plasma power, Substrate preheating temperature and Atomizing gas kind and flow rate on Spray distance that lower than it coatings have a snowy like appearance

Plasma power (KW)	Atomizing gas	Substrate preheating temperature (°C)	Atomizing gas flow rate at pressure of 3.5 bar (slpm)	Spray distance that lower than it coatings have a snowy like appearance (cm)
18.5	O ₂	200	6	10
34.5	O ₂	200	6	14
34.5	H ₂	200	6	16
34.5	H ₂	200	8	18
34.5	O ₂	500	6	18

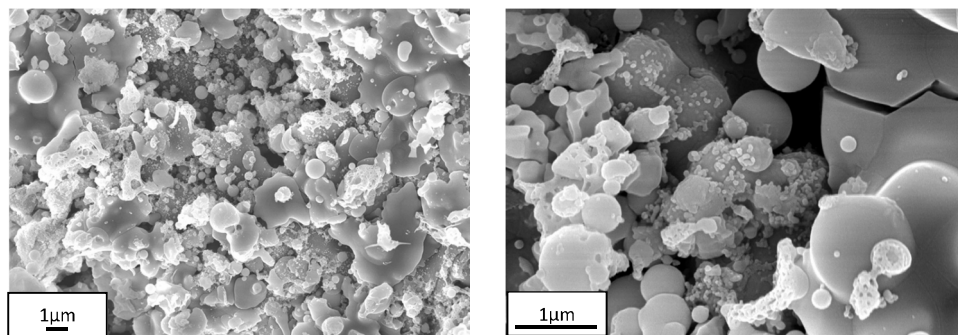

Fig. 9. SEM images of the surface of coating produced under the condition of test 2 at spray distance of 6cm.

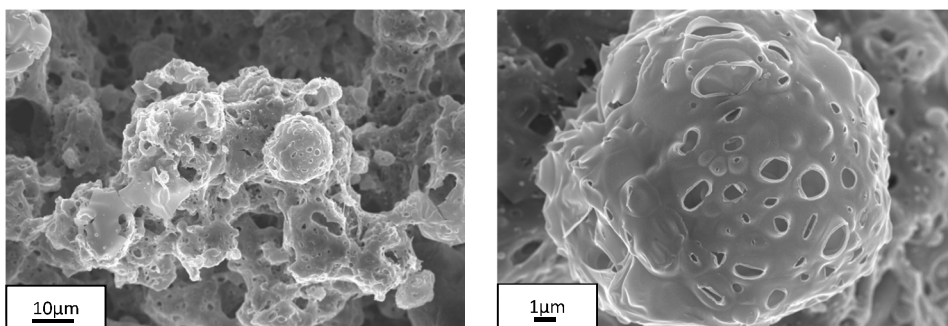

Fig. 10. SEM images of the surface of coating produced under the condition of test 2 at spray distance 16cm.

that solidified and crystallized before impact to the substrate. They adhere to the substrate after being captured by gel or softer deposit phases [21].

Fig.10 shows the surface of coatings produced under the condition of test 2 at spray distance of 16 cm. Spherical particles with diameter of 20 μm are seen in the microstructure which are the size of precursor atomized in the plasma jet. So it can be concluded that these particles did not undergo the breakup process in the plasma jet and entered the colder part of plasma plume. The particles that have entered the hot zone of plasma plume and undergo the breakup process do not reach the substrate surface at higher spray distance. For atomized particles that have entered the cold portion of plasma and have not undergo the breakup process there is not enough heat for pyrolyzation, crystallization and melting

processes while such processes just start and occur on the surface of particles. The holes produced on the outer surface of spherical particles show that at first outer shell of the particles has been pyrolyzed and then evaporation of water content of un-pyrolyzed solution create the holes. Similar phenomena have been pointed out in some references [23-26]. These structural features are spherical particles appearance observed before in optical image microscopy and XRD of them seen in Fig. 7(c) showed a lot of unpyrolyzed precursor.

Fig. 11 shows the SEM image from the surface of the coating produced under the condition of test 3 at spray distance of 6 cm. The structure of this coating also composes of splats and particles with the diameter in the range of less than 500 nm to more than 1000 nm and by comparison with Fig. 9, it can be seen that the amount of

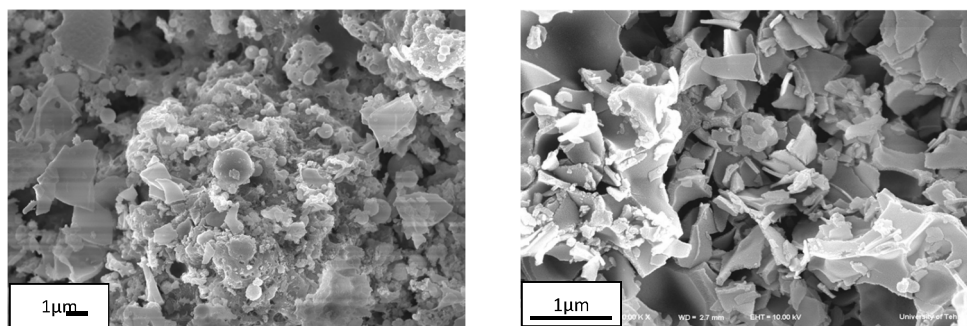

Fig. 11. SEM images of the surface of coating produced under the condition of test 3 at spray distance of 6cm.

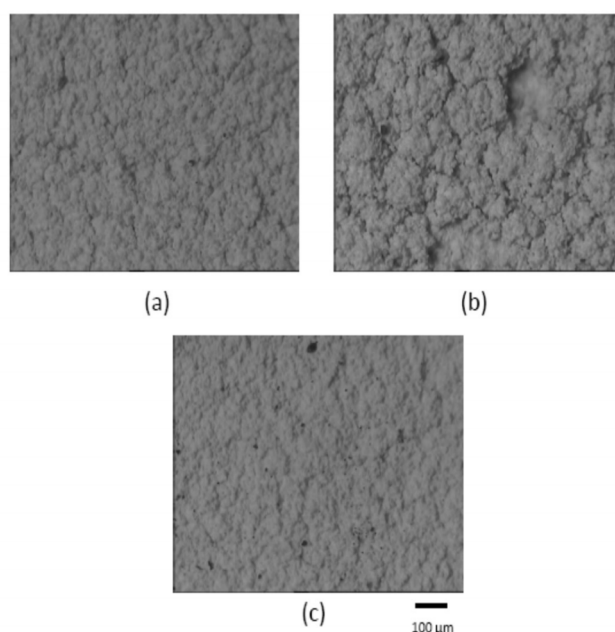

Fig. 12. Optical microscopy images from the surface of coated specimens under the conditions of (a) O₂ atomizing at spray distance of 6 cm , (b) O₂ atomizing at spray distance of 16 cm and (c) H₂ atomizing at spray distance of 6 cm after 500 thermal cycles.

unpyrolyzed precursor and spherical particles are reduced and the amount of splats are increased.

3. 5. The Results of Thermal Cycle Resistance Test

After 500 thermal cycles the surfaces of the coatings produced under the conditions of test 2 at spray distances of 6 and 16 cm and test 3 at spray distance of 16 cm were examined by optical microscope. The results are shown in Fig. 12. In coating produced by O₂ atomizing at spray distance of 6 cm (Fig. 12 (a)), some cracks on the

surface can be seen while for the coating produced by O₂ atomizing at spray distance of 16 cm (Fig. 12 (b)), spallation of the coating has been occurred. This result can be explained by too much unpyrolyzed precursor in coating produced at spray distance of 16 cm. Coating produced by H₂ atomizing at spray distance of 6 cm (Fig. 12 (c)) was sound after 500 thermal cycles. This result can be due to higher splat formation and lower unpyrolyzed precursor in this coating.

4. CONCLUSION

The morphology of SPPS YSZ coatings depends on spray parameters specially plasma enthalpy. Increasing the power of plasma decreases the un-pyrolyzed precursor in coating structure. Using H₂ as the precursor atomizing gas by increasing the plasma temperature and enthalpy has the same effect. Successive passes of plasma torch transfer heat to coating already formed on the substrate and cause pyrolyzation of un-pyrolyzed precursor in the coating. This effect is severe at lower spray distances. Increasing the preheating temperature of substrate before applying the coating helps pyrolyzation to occur. Existence of too much un-pyrolyzed precursor in the coating can cause cracking due to pyrolyzation. Increasing the temperature of substrate more than about 800 °C prevent coating formation.

Using H₂ as the precursor atomizing gas, showed improvement in thermal shock resistance of coatings due to lower unpyrolyzed precursor and higher splat formation.

REFERENCES

1. Gleeson, B., "Thermal Barrier Coatings for Aeroengine applications", *Journal of Propulsion and Power*, 2006, Vol 22, 375-383.
2. Meier, S. M., Gupta, D. K. and Sheffler, K. D., "Ceramic Thermal. Barrier Coatings for Commercial Gas Turbine Engines", *J. Met.*, 1991, Vol. 43, 50-53.
3. Jones, R. L., Stern, K. H., "Metallurgical and Ceramic Coatings, Chapman and Hall", London, 1996, 194.
4. Evans, A. G., Mumm, D. R., Hutchinson, J. W., Meier, G. H. and Pettit, F. S., "Mechanisms Controlling the Durability of Thermal Barrier Coatings", *Progress in Materials Science*, 2001, 46, 505-553.
5. Strutt, P. R., Kear, B. H. and Boland, R. F., "Method of Manufacture of Nanostructured Feeds," U.S. Patent Number 6025034, February 15, 2000.
6. Parukuttyamma, S. D., Margolis, J., Liu, H., Grey, C. P., Sampath, S., Herman, H., and Parise, J. B., "Yttrium Aluminum Garnet (YAG) Films Through a Precursor Plasma Spraying Technique", *Journal of American Ceramic Society*, 2001, 84/8, 1906-1908.
7. Padture, N. P., Schlichting, K. W., Bhatia, T., Ozturk, A., Cetegen, B., Jordan, E. H., Gell, M., Jiang, S., Xiao, T. D., Strutt, P. R., Garcia, E., Miranzo, P., Osendi, M. I., "Towards Durable Thermal Barrier Coatings with Novel Microstructures Deposited by Solution Precursor Plasma Spray", *Acta Materialia*, 2001, 49, 2251-2257.
8. Karthikeyan, J., Berndt, C. C., S. Reddy, Wang, J. Y., King, A. H., Herman, H., "Nanomaterial Deposits Formed by DC Plasma Spraying of Liquid Feedstocks", *Journal American Ceramic Society*, 1998, 81, 121-128.
9. Bhatia, T., Ozturk, A., Xie, L., Jordan, E., Cetegen, B., Gell, M., X. Ma, N. Padture, "Mechanisms of Ceramic Coating Deposition in Solution Precursor Spray", *Journal of Material Research*, 2001, 17, 2363-2372.
10. Bouyer, E., Schiller, G., Muller, M., Heane, R. H., "Thermal Plasma Chemical Vapor Deposition of Si-Based Ceramic Coatings from Liquid Precursors", *Plasma Chemistry and Plasma Processing*, 2001, 21/4, 523-546.
11. Jadhav, A., N., Padture, Wu, F., Jordan, E., Gell, M., "Thick Ceramic Thermal Barrier Coatings with High Durability Deposited Using Solution-Precursor Plasma Spray", *Materials Science and Engineering A*, 2005, 405, 313-320.
12. Bouyer, E., Gitzhofer, F., Boulos, M., "Progress in Plasma Processing of Materials", Ed. P. Fauchais, Begell House, NY, USA, 1997, 735-750.
13. Gitzhofer, F., Bonneau, M. E. and Boulos, M., "Thermal Spray 2001: New Surfaces For A New Millennium", Eds. C.C. Berndt, K.A. Khor, E. Lugscheider, ASM International, Materials Park, OH, USA, 2001, 61-68.
14. Fauchais, P., Rat, V., Delbos, C., Coudert, J. F., Chartier, T. and Bianchi, L., "Understanding of Suspension DC Plasma Spraying of Finely Structured Coatings for SOFC", *IEEE Transactions on Plasma Science*, 2005, 33/2, 920-930.
15. Bhatia, T., Ozturk, A., Xie, L., Jordan, E., Cetegen, B., Gell, M., Ma, X. and Padture, N.,

- “Mechanisms of Ceramic Coating Deposition in Solution Precursor Spray”, *Journal of Material Research*, 2001, 17, 2363-2372.
16. Xie, L., Ma, X., Jordan, E. H., Padture, N. P., Xiao, T. D., Gell, M., “Highly Durable Thermal Barrier Coatings Made by the Solution Precursor Plasma Spray Process”, *Surface and Coatings Technology*, 2004, 177/178, 97-102.
 17. Jordan, E. H., Xie, L. Ma, C., Gell, M., Padture, N., Cetegen, B., Roth, J., Xiao, T. D. and Bryant, P. E. C., “Superior Thermal Barrier Coatings Using Solution Precursor Plasma Spray”, *Journal of thermal spray*, 2004, 13, 57-65.
 18. Fauchais, P., Rat, V., Coudert, J. F., Etchart-Salas, R. and Montavon, G., “Operating Parameters for Suspension and Solution Plasma-Spray Coatings”, *Surface & Coatings Technology*, 2008, 202, 4309-4317.
 19. Chen, D., Gell, M., Jordan, E. H., Cao, E. and Ma, X., “Thermal Stability of Air Plasma Spray and Solution Precursor Plasma Spray Thermal Barrier Coatings”, *Journal of American Ceramic Society*, 2007, 90/10, 3160-3166.
 20. Martin, U., Boysen, H., Frey, F., “Acta Crystallogr”, *Sec. B: Structural Science*, 1993, 49, 403.
 21. Gell, M., Jordan, E. H., Teicholz, M., Cetegen, B. M., Padture, N. P., Xie, L., Chen, D., Ma, X. and Roth, J., “Thermal Barrier Coatings Made by the Solution Precursor Plasma Spray Process”, *Journal of Thermal Spray Technology*, 2008, 17, 124-135.
 22. Xie, L., Chen, D., Jordan, E. H., Ozturk, A., Wu, F., Ma, X., Cetegen, B. M. and Gell, M., “Formation of Vertical Cracks in Solution-Precursor Plasma-Sprayed Thermal Barrier Coatings”, *Surface and Coatings Technology*, 2006, 201, 1058-1064.
 23. Xie, L., Ma, X., Ozturk, A., Jordan, E. H., Padture, N. P., Cetegen, B. M., Xiao, D. T. and Gell, M., “The Effects of Processing Parameters on the Spray Patterns Produced in the Solution Precursor Plasma Spray of Thermal Barrier Coatings”, *Surface and Coatings Technology*, 2004, 183, 51-61.
 24. Xie, L., Ma, X., Jordan, E. H., Padture, N. P., Xiao, D. T. and Gell, M., “Deposition of Thermal Barrier Coatings Using Solution Precursor Plasma Spray Process”, *J. Mater. Sci.*, 2004, 39, 1639-1636.
 25. Ozturk, A. and Cetegen, B. M., “Modeling of Axially and Transversely Injected Precursor Droplets into a Plasma Environment”, *International Journal of Heat and Mass Transfer*, *International Journal of Heat and Mass Transfer*, 2005, 48, 4367-4383.
 26. Ozturk, A. and Cetegen, B. M., “Modeling of Axial Injection of Ceramic Precursor Droplets into an Oxy-Acetylene Flame Environment”, *Mater. Sci. Eng. A*, 2006, 422, 163-175.